



MARQUE: MOULINEX
REFERENCE: OX485E10 OPTIMO BL
CODIC: 4248910



NOTICE



Moulinex®

m4000

FR

NL

DE

EN

ES

PT

IT



www.moulinex.com

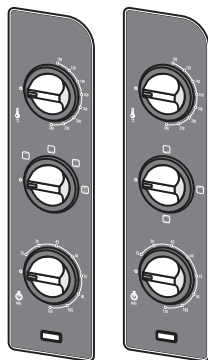
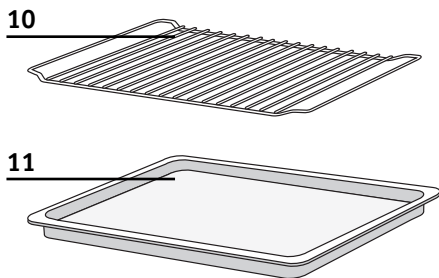
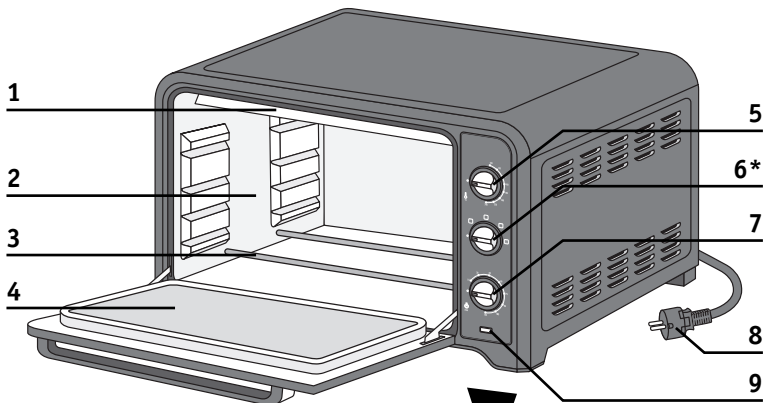

* selon modèle
 afhankelijk van het model
 depending on the model
 según el modelo
 consoante o modelo
 in base al modello

1 Description - Beschrijving - Beschreibung Descripción - Descrição - Descrizione

- | | |
|--|------------------------------------|
| 1 Résistance supérieure | 1 Bovenste verwarmingselement |
| 2 Parois aluminium | 2 Aluminium wanden |
| 3 Résistance inférieure | 3 Onderste verwarmingselement |
| 4 Porte double parois | 4 Dubbelwandige deur |
| 5 Bouton de réglage température | 5 Regelbare thermostaatknop |
| 6 Bouton des fonctions | 6 Functieknop |
| 7 Bouton de minuterie | 7 Timerknop |
| 8 Cordon d'alimentation | 8 Snoer |
| 9 Voyant de fonctionnement | 9 Aan/uit-controlelampje |
| 10 Grille réversible | 10 Omkeerbaar rooster |
| 11 Plat lèche-frite | 11 Opvangbak voor vet |
| | |
| 1 Oberes Heizelement | 1 Top heating element |
| 2 Aluminiumwände | 2 Aluminium walls |
| 3 Unteres Heizelement | 3 Bottom heating element |
| 4 Doppelwandige Tür | 4 Double-wall door |
| 5 Temperaturregler | 5 Temperature control button |
| 6 Funktionsknopf | 6 Functions button |
| 7 Timer-Knopf | 7 Timer button |
| 8 Netzkabel | 8 Power cord |
| 9 Betriebskontrollleuchte | 9 Power indicator light |
| 10 Umkehrbarer Rost | 10 Reversible shelf |
| 11 Emaillierte Bratschale | 11 Drip tray |
| | |
| 1 Resistencia superior | 1 Resistência superior |
| 2 Paredes aluminio | 2 Paredes alumínio |
| 3 Resistencia inferior | 3 Resistência inferior |
| 4 Puerta de doble cristal | 4 Porta de parede dupla |
| 5 Botón de ajuste de temperatura | 5 Botão deregulação da temperatura |
| 6 Botón de funciones | 6 Botão das funções |
| 7 Botón de temporizador | 7 Botão temporizador |
| 8 Cable de alimentación | 8 Cabo de alimentação |
| 9 Indicador de funcionamiento | 9 Luz piloto de funcionamento |
| 10 Rejilla reversible | 10 Grelha reversível |
| 11 Bandeja | 11 Tabuleiro |
| | |
| 1 Resistenza superiore | |
| 2 Pareti alluminio | |
| 3 Resistenza inferiore | |
| 4 Sportello a parete doppia | |
| 5 Bottone di regolazione della temperatura | |
| 6 Bottone di selezione delle funzioni | |
| 7 Bottone del timer | |
| 8 Cavo d'alimentazione | |
| 9 Spia di funzionamento | |
| 10 Griglia reversibile | |
| 11 Piatto leccarda | |

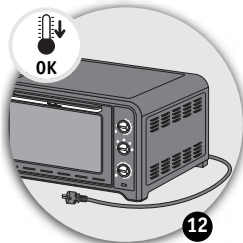
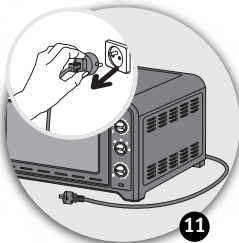
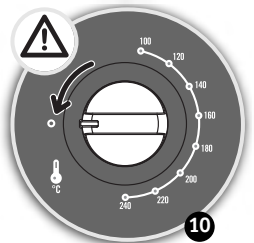
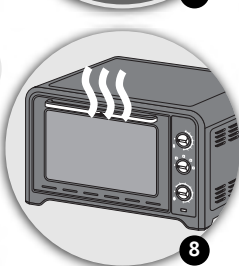
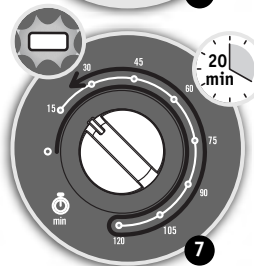
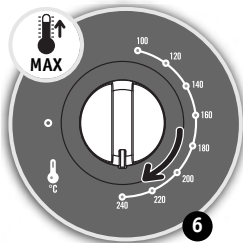
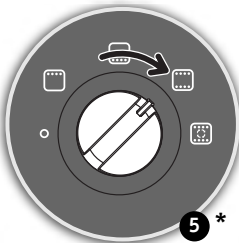
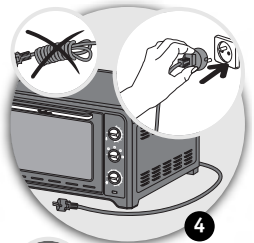
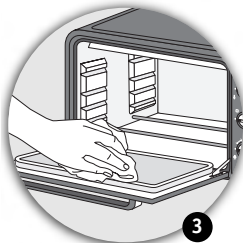
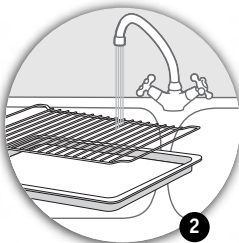
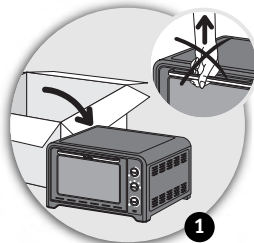

3 

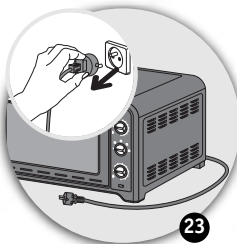
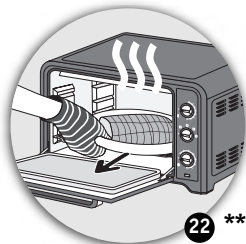
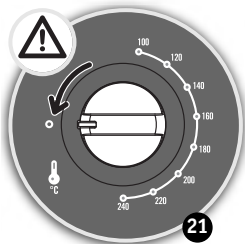
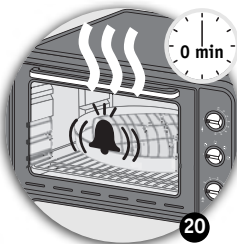
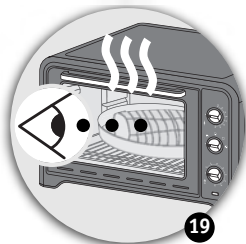
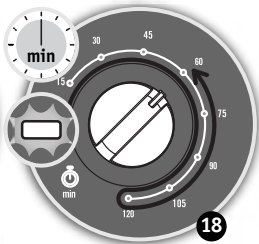
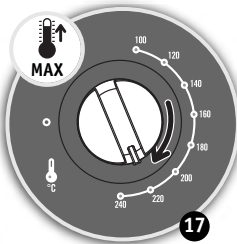
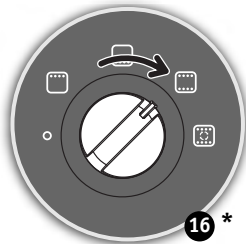
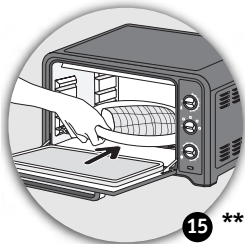
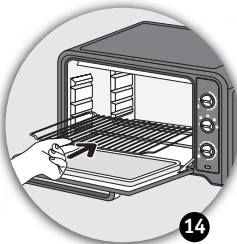
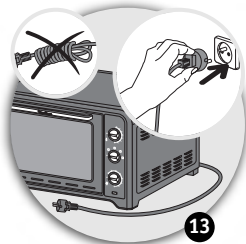

* selon modèle - afhankelijk van het model
je nach Modell - depending on the model
según el modelo - consoante o modelo
in base al modello

** Plat non fourni avec l'appareil
Schaal niet inclusief bij het apparaat
Platte nicht im Lieferumfang begriffen
The dish is not supplied with the appliance
El plato no es suministrado con el aparato
Travessa não fornecida com o aparelho
Il piatto non è fornito con l'apparecchio

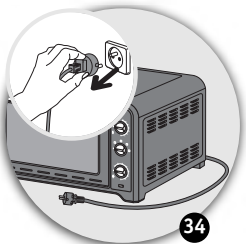
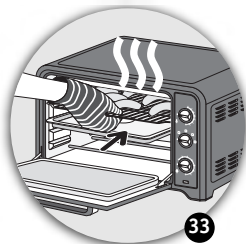
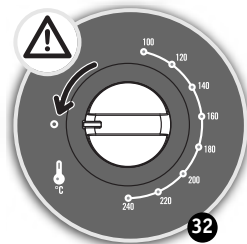
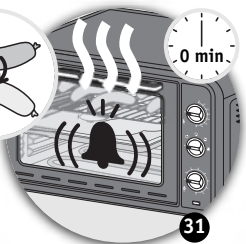
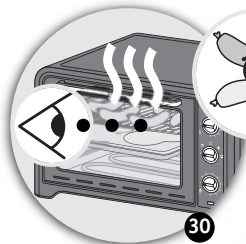
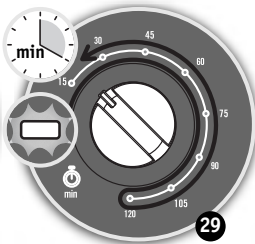
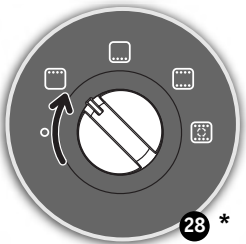
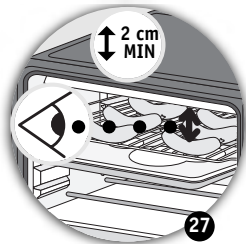
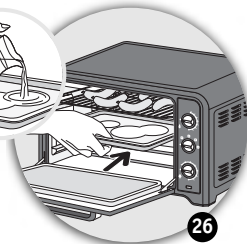
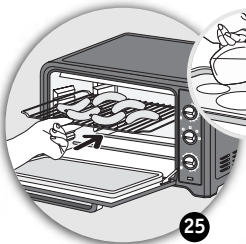
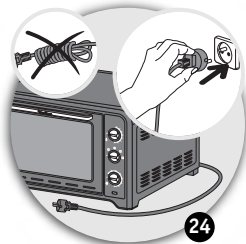

5  *

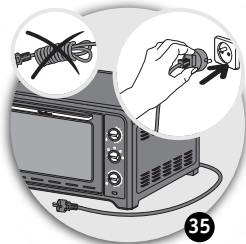

35

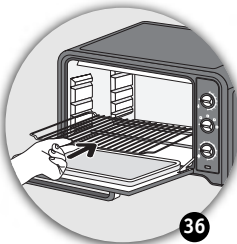

36

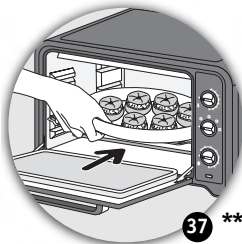

37 **

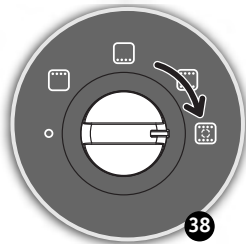

38

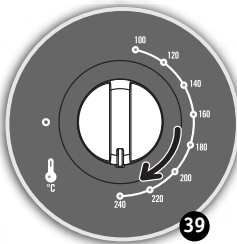

39

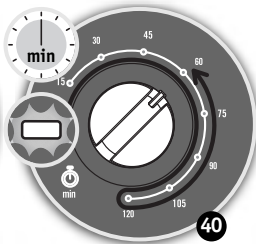

40

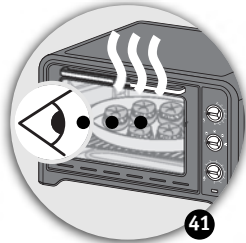

41

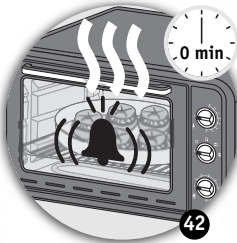

42

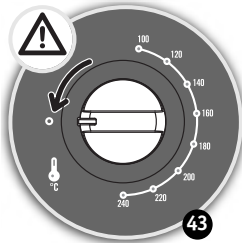

43

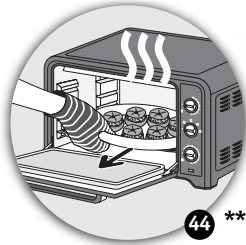

44 **

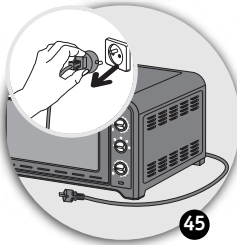

45

* selon modèle - afhankelijk van het model
je nach Modell - depending on the model
según el modelo - consoante o modelo
in base al modello

** Plat non fourni avec l'appareil
Schaal niet inclusief bij het apparaat
Platte nicht im Lieferumfang begriffen
The dish is not supplied with the appliance
El plato no es suministrado con el aparato
Travessa não fornecida com o aparelho
Il piatto non è fornito con l'apparecchio

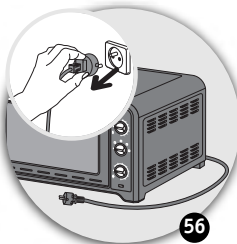
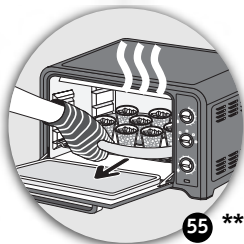
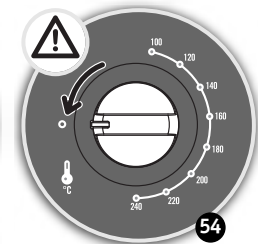
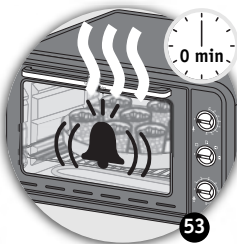
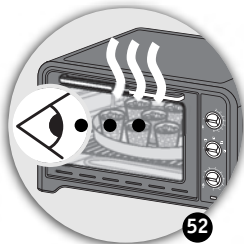
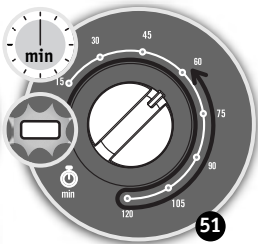
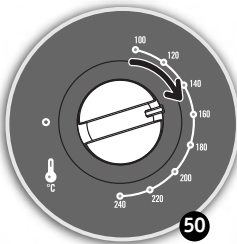
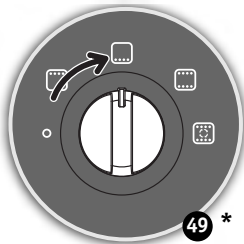
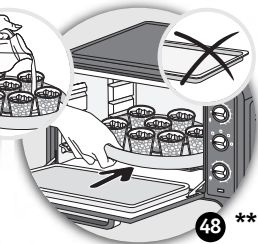
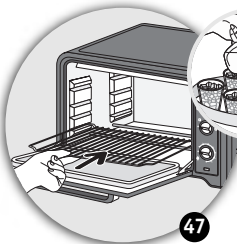
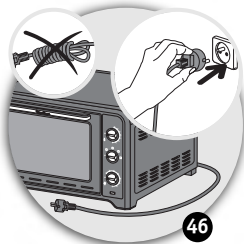

* selon modèle - afhankelijk van het model
je nach Modell - depending on the model
según el modelo - consoante o modelo
in base al modello

** Plat non fourni avec l'appareil
Schaal niet inclusief bij het apparaat
Platte nicht im Lieferumfang begriffen
The dish is not supplied with the appliance
El plato no es suministrado con el aparato
Travessa não fornecida com o aparelho
Il piatto non è fornito con l'apparecchio

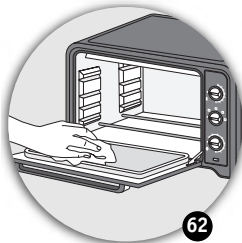
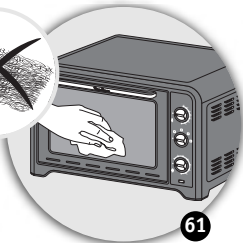
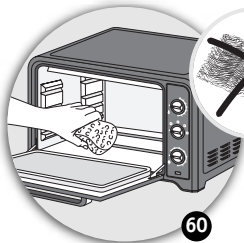
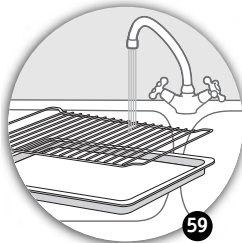
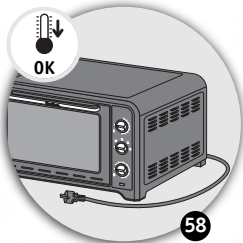
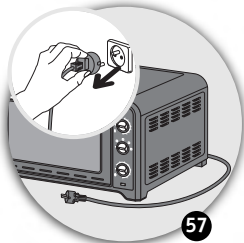



	x 4			10 min	240	20
	1,5 Kg			10 min	230	60
	750 gr			10 min	240	25
	1 Kg			---	230	80
	x 4		 	---	240	22 + 9
	x 8		 	---	240	15 + 5
	350 gr			10 min	210	15
				10 min	240	45
	650 gr			10 min	240	16
				---	240	28
				10 min	200	45
				10 min	200	20
				---	135	53
				10 min	230	55
				10 min	240	25

* selon modèle - afhankelijk van het model - je nach Modell - depending on the model - según el modelo - consoante o modelo - in base al modello

9

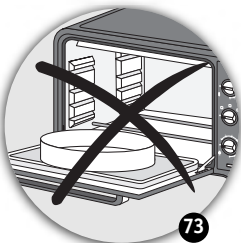
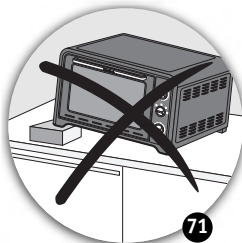
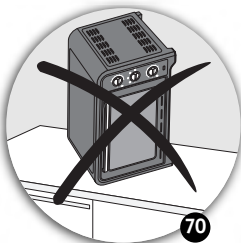
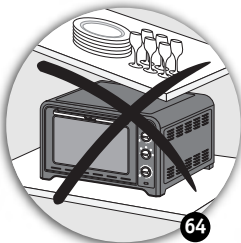
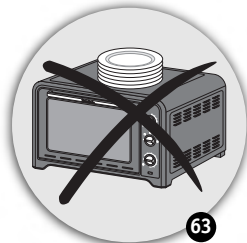

Parmentier de bœuf et tomate à l'origan

6 ramequins de 200 ml - Sans préchauffage - Préparation : 25 min - Cuisson : 52 min à 150°
- Grille niveau 1

- 400 g de pommes de terre lavées (type Charlotte)
- 400 g de bœuf haché 5% de matières grasses
- 8 cuillères à soupe de pulpe de tomates
- 1 oignon nouveau émincé finement
- 30 g de beurre en petits morceaux
- 2 cuillères à soupe de crème épaisse légère
- 1 cuillère à soupe d'origan
- 1 cuillère à soupe d'huile d'olive
- Quelques gouttes de Tabasco® (selon votre appréciation)
- Quelques branches de thym frais pour la décoration
- Sel et poivre

1. Mettez les pommes de terre en vapeur pendant 25-30 min.
2. Assaisonnez le bœuf haché avec l'oignon, l'huile d'olive, le sel, le poivre et quelques gouttes de Tabasco®. Une fois les pommes de terre cuites, épluchez-les, puis écrasez-les à l'aide d'une fourchette, ajoutez le beurre et la crème épaisse.
3. Montez les "Parmentier" dans les ramequins. Commencez par une couche de bœuf, puis de tomates parsemées d'origan et de pommes de terre, puis renouvelez ce montage. Placez les ramequins dans le plat rempli d'eau et mettez le tout au four sur la grille placée niveau 1, pendant 52 minutes à 150°. Au moment de servir, ajoutez de la pulpe de tomate et une branche de thym sur chaque ramequin.

Suggestion : servez avec une salade (roquette, mesclun).

Gâteau fondant au chocolat

4 ramequins pour 4 personnes - Sans préchauffage - Préparation : 15 min - Cuisson : 53 min à 135°
- Grille niveau 2

- 120 g de chocolat noir à 64% minimum
- 40 g de beurre en pommade
- 2 jaunes d'œufs
- 3 blancs d'œufs montés en neige
- 50 g de sucre en poudre
- 3 cuillères à soupe de farine

1. Mettez à fondre dans une casserole le chocolat et le beurre. Mélangez les jaunes et le sucre puis ajoutez la farine. Versez-y le chocolat et le beurre fondus. Incorporez un tiers des blancs montés en neige au fouet et le reste à la spatule.
2. Remplissez les ramequins avec la préparation. Placez-les dans un plat rempli d'eau et mettez le tout au four sur la grille placée niveau 2 pendant 53 minutes à 135°.
3. Servez tiède ou froid.

INTERNATIONAL GUARANTEE : COUNTRY LIST

			
الجزائر ALGERIA	(0)41- 28 18 53	سنة واحدة 1 year	CIJA 9 rue Puvis de Chavannes - Saint Euquene Oran
ARGENTINA	0800-122-2732	2 años 2 years	GRUPE SEB ARGENTINA S.A. Billinghurst 1833 3°, C.1425DTK Capital Federal - Buenos Aires
ՀԱՅԱՍՏԱՆ ARMENIA	(010) 55-76-07	2 տարի 2 years	ՓԲԸ "Գրուպա ՍԵԲ", 125171, Մոսկվա, Լենինգրադյան խմբակի, 16A, շին.3
AUSTRALIA	02 97487944	2 years	GRUPE SEB AUSTRALIA PO Box 7535, Silverwater - NSW 2128
ÖSTERREICH AUSTRIA		2 Jahre 2 years	SEB ÖSTERREICH GmbH Campus 21 - Businesspark Wien Süd, Liebermannstr. A02 702 - 2345 Brunn am Gebirge
БЕЛАРУСЬ BELARUS	017 2239290	2 года 2 years	ЗАО «Группа СЕБ-Восток», 125171, Москва, Ленинградское шоссе, д. 16А, стр. 3
BELGIQUE-BELGIE BELGIUM	070 23 31 59	2 ans 2 years	GRUPE SEB BELGIUM SA NV 25 avenue de l'Espérance - ZI - 6220 Fleurus
BOSNA I HERCEGOVINA	Info-linija za potrošače 033 551 220	2 godine 2 years	SEB Développement Predstavništvo u BiH - Vrazova 8/II 71000 Sarajevo
BRASIL BRAZIL	0800-119933	1 ano 1 year	SEB COMERCIAL DE PRODUTOS DOMÉSTICOS LTDA Rua Venâncio Aires, 433/437/447, Pompéia, São Paulo/SP
БЪЛГАРИЯ BULGARIA	0700 10 330	2 години 2 years	ГРУП СЕБ БЪЛГАРИЯ ЕООД бул. България 81 В, ет. 5 - 1404 София
CANADA	1-800-418-3325	1 an 1 year	GRUPE SEB CANADA 345 Passmore Avenue Toronto, ON - M1V 3N8
CHILE	12300 209207	2 años 2 years	GRUPE SEB CHILE Comercial Ltda Av. Providencia, 2331, piso 5, Oficina 501 - Santiago
COLOMBIA	18000919288	2 años 2 years	GRUPE SEB COLOMBIA Apartado Aereo 172, Kilometro 1 Via Zipaquirá - Cajica Cundinamarca
HRVATSKA CROATIA	01 30 15 294	2 godine 2 years	SEB Développement S.A.S. Vodnjanska 26, 10000 Zagreb
ČESKÁ REPUBLIK CZECH REPUBLIC	731 010 111	2 roky 2 years	GRUPE SEB ČR spol. s r. o. Jankovcova 1569/2c - 170 00 Praha 7
DANMARK DENMARK	44 663 155	2 år 2 years	GRUPE SEB NORDIC AS Tempovej 27 - 2750 Ballerup
EESTI ESTONIA	5 800 3777	2 aastat 2 years	GRUPE SEB POLSKA SP. z o.o. ul. Bukowińska 22b - 02-703 Warszawa
مصر EGYPT	الخط الساخن : 16622	سنة واحدة 1 year	جروب سب ايجيبت طريق 14 مايو - سموحه الإسكندرية - مصر
SUOMI FINLAND	09 622 94 20	2 Vuotta 2 years	Groupe SEB Finland Kutojantie 7 - 02630 Espoo
FRANCE Continentale + Guadeloupe, Martinique, Réunion, Saint-Martin	09 74 50 10 14	1 an 1 year	GRUPE SEB FRANCE Service Consommateur Moulinex BP 15 - 69131 ECULLY CEDEX

			
DEUTSCHLAND GERMANY	0212 387 400	2 Jahre 2 years	GRUPE SEB DEUTSCHLAND GmbH KRUPS GmbH Herrnrainweg 5 - 63067 Offenbach
ΕΛΛΑΔΑ GREECE	2106371251	2 χρόνια 2 years	SEB GROUPE ΕΛΛΑΔΟΣ Α.Ε. Οδός Καβαλιεράτου 7 Τ.Κ. 145 64 Ν. Κηφισιά
香港 HONG KONG	8130 8998	1 year	SEB ASIA Ltd. Room 903, 9/F, South Block, Skyway House 3 Sham Mong Road, Tai Kok Tsui, Kowloon - Hong-Kong
MAGYARORSZÁG HUNGARY	06 1 801 8434	2 év 2 years	GRUPE SEB CENTRAL-EUROPE Kft. Táviró köz 4 - 2040 Budaörs
INDONESIA	+62 21 5793 6881	1 year	Groupe SEB Indonesia (Representative office) Sudirman Plaza, Plaza Marein 8th Floor JL Jendral Sudirman Kav 76-78, Jakarta 12910, Indonesia
ITALIA ITALY	1 99 207 892	2 anni 2 years	GRUPE SEB ITALIA S.p.A. Via Montefeltro, 4 - 20156 Milano
日本 JAPAN	0570 077 772	1 year	株式会社グループセブジャパン - 〒141-0022 東京都品川区東五反田3-14-13 - 高輪ミュージアビル
ҚАЗАҚСТАН KAZAKHSTAN	727 378 39 39	2 жыл 2 years	ЖАҚ «Группа СЕБ- Восток» 125171, Мәскеу, Ленинградское шоссесі, 16А, 3 үйі
한국어 KOREA	1588-1588	1 year	(유)그룹 세브 코리아 서울시 종로구 서린동 88 서린빌딩 - 3층, 110-790
LATVJA LATVIA	6 716 2007	2 gadi 2 years	GRUPE SEB POLSKA Sp. z o.o. ul. Bukowińska 22b 02-703 Warszawa
LIETUVA LITHUANIA	6 470 8888	2 years	GRUPE SEB POLSKA Sp. z o.o. ul. Bukowińska 22b 02-703 Warszawa
LUXEMBOURG	0032 70 23 31 59	2 ans 2 years	GRUPE SEB BELGIUM SA NV 25 avenue de l'Espérance - ZI - 6220 Fleurus
МАКЕДОНИЈА MACEDONIA	(0)2 2050 022	2 години 2years	Groupe SEB Bulgaria EOOD Office 1, floor 1, 52G Borovo St., 1680 Sofia - Bulgaria ГРУП СЕБ БЪЛГАРИЯ ДООЕЛ Ул. Борово 52 Г, сл. 1, офис 1, 1680 София - България
MALAYSIA	603 7710 1175	1 year	GRUPE SEB MALAYSIA SDN. BHD Unit No. 402-403, Level 4, Uptown 2, No. 2, Jalan SS21/37, Damansara Uptown, 47400, Petaling Jaya, Selangor D.E. Malaysia
MEXICO	(01800) 112 8325	1 año 1 year	Groupe.S.E.B. México, S.A. DE C.V. Goldsmith 38 Desp. 401, Col. Polanco Delegación Miguel Hildalgo - 11 560 México D.F.
MOLDOVA	(22) 929249	2 ani 2 years	ТОВ «Груп СЕБ Україна» 02121, Харківське шосе, 201-203, 3 поверх, Київ, Україна
NEDERLAND The Netherlands	0318 58 24 24	2 jaar 2 years	GRUPE SEB NEDERLAND BV De Schutterij 27 - 3905 PK Veenendaal - Nederland
NEW ZEALAND	0800 700 711	1 year	GRUPE SEB NEW ZEALAND Unit E, Building 3, 195 Main Highway, Ellerslie, Auckland
NORGE NORWAY	815 09 567	2 år 2 years	GRUPE SEB NORDIC AS Tempovej 27 - 2750 Ballerup
PERU	441 4455	1 año 1 year	Groupe SEB Perú Av. Camino Real N° 111 of. 805 B - San Isidro - Lima

			
POLSKA POLAND	0801 300 423 koszt jak za połączenie lokalne	2 lata 2 years	GRUPE SEB POLSKA Sp. z o.o ul. Bukowińska 22b 02-703 Warszawa
PORTUGAL	808 284 735	2 anos 2 years	GRUPE SEB IBÉRICA SA Urb. da Matinha - Rua Projectada à Rua 3 Bloco1 - 3º B/D 1950 - 327 Lisboa
REPUBLIC OF IRELAND	01 677 4003	1 year	GRUPE SEB IRELAND Unit B3 Aerodrome Business Park, College Road, Rathcoole, Co. Dublin
ROMÂNIA ROMANIA	0 21 316 87 84	2 ani 2 years	GRUPE SEB ROMÂNIA Str. Daniel Constantin nr. 8 - 010632 Bucuresti
РОССИЯ RUSSIA	495 213 32 29	2 года 2 years	ЗАО «Группа СЕБ-Восток», 125171, Москва, Ленинградское шоссе, д. 16А, стр. 3
SRBIJA SERBIA	060 0 732 000	2 godine 2 years	SEB Developpement Đorđa Stanojevića 11b 11070 Novi Beograd
SINGAPORE	6550 8900	1 year	GRUPE SEB SINGAPORE Pty Ltd. 59 Jalan Pemimpin, #04-01/02 L&Y Building Singapore 577218
SLOVENSKO SLOVAKIA	233 595 224	2 roky 2 years	GRUPE SEB SLOVENSKO spol. s.r.o. Rybničná 40 - 831 06 Bratislava
SLOVENIJA SLOVENIA	02 234 94 90	2 leti 2 years	SEB d.o.o Gregorčičeva ulica 6 - 2000 MARIBOR
ESPAÑA SPAIN	902 31 22 00	2 años 2 years	GRUPE SEB IBÉRICA S.A. C/ Almogàvers, 119-123, Complejo Ecourban 08018 Barcelona
SVERIGE SWEDEN	08 594 213 30	2 år 2 years	TEFAL SVERIGE SUBSIDIARY OF GROUP SEB NORDIC Truckvägen 14 A, 194 52 Upplands - Väsby
SUISSE / SCHWEIZ SWITZERLAND	044 837 18 40	2 ans 2 Jahre 2 years	GRUPE SEB SCHWEIZ GmbH Thurgauerstrasse 105 8152 Glattbrugg
台灣 TAIWAN	02 28333716	1 year	SEB ASIA Ltd. Taiwan Branch 4F., No. 37 Dexing W. Rd., Shilin Dist., Taipei City 11158, Taiwan (R.O.C.)
ประเทศไทย THAILAND	02 769 7477	2 years	GRUPE SEB THAILAND 2034/66 Italthai Tower, 14th Floor, n° 14-02, New Phetchburi Road, Bangkapi, Huaykwang, Bangkok, 10320
TÜRKIYE TURKEY	216 444 40 50	2 YIL 2 years	GRUPE SEB ISTANBUL AS Beybi Giz Plaza Dereboyu Cad. - Meydan Sok. No: 28 K.12 Maslak
U.S.A.	800-395-8325	1 year	GRUPE SEB USA 2121 Eden Road - Millville, NJ 08332
УКРАЇНА UKRAINE	044 300 13 04		ТОВ «Груп СЕБ Україна» 02121, Харківське шосе, 201-203, 3 поверх, Київ, Україна
UNITED KINGDOM	0845 602 1454	1 year	GRUPE SEB UK LTD Riverside House, Riverside Walk Windsor, Berkshire, SL4 1NA
VENEZUELA	0800-7268724	2 años 2 year	GRUPE SEB VENEZUELA Av Eugenio Mendoza, Centro Letonia, Torre ING Bank, Piso 15, Ofc 155 - Urb. La Castellana, Caracas
VIETNAM	08 38645830	1 year	Vietnam Fan Joint Stock Company 25 Nguyen Thi Nho Str, Ward 9, Tan Binh Dist, HCM city

MOULINEX INTERNATIONAL GUARANTEE

Date of purchase: / Date d'achat / Fecha de compra / Data da compra / Data d'acquisto / Kaufdatum / Aankoopdatum / Købsdato / Inköpsdatum / Kjøpsdato / Ostopäivä / Data zakupu / Data vânzării / Įsigijimo data/ Ostukuupäev / Datum nakupa / Sorozatszám / Dátum nákupu / Pirkuma datums / Datum Kupovine / Datum kupnje / Data cumpărării / Datum nákupu / Tarikh pembelian / Tanggal pembelian / Ngày mua hàng/ Satin alma tarihi / Дата прџдажи / Дата на закупуване / Датум на купуваое / Сатылган мерзими / Ημερομηνία αγοράς/ Վեճմանքի օրը / วันที่ซื้อ / 購買日期/購入日 / 구입일자 / تاريخ الشراء/ تاريخ خرید

Product reference: / Référence du produit / Referencia del producto / Referência do produto / tipo de prodotto / Typnummer des Gerätes / Artikelnummer van het apparaat / Referencenummer / Produktreferens / Artikelnummer / Tuotenumero / referenja produktu / Model / Gaminio numeris / Tootte viitenumber / Tip aparata / Vásárlás kelte / Typ výrobku / Produkta atsauces numurs / Model proizvoda / Oznaka proizvoda / Cod produs / Produk rujukan / Referensi produk / Mã sản phẩm/ Ürün kodu / Модель / Мпдель / Мпдел на уреда / Мпдели / Κωδικός προϊόντος / Όηηηη / รุ่นผลิตภัณฑ์ / 產品模型 / 製品レファレンス番号/제품명 / مرجع كامل محصول / مرجع المنتج الكامل

Retailer name & address: / Nom et adresse du vendeur / Nombre y dirección del minorista / Nome e endereço do revendedor / Nome e indirizzo delnegozio / Name und Anschrift des Händlers / Naam en adres van de retailer / Forhandler navn & adresse / Återförsäljarens namn och adress / Forhandler navn og adresse / Jälleenmyyjän nimi ja osoite / nazwa i adres sprzedawcy / Numele și adresa vânzătorului / Parduotuvės pavadinimas ir adresas / Müüja kauplus ja aadress / Naziv in naslov trgovine / Tipusszám / Názov a adresa predajcu / Veikala nosaukums un adrese / Naziv i adresa maloprodaje / Naziv i adresa prodavca / Naziv i adresa prodajnog mjesta / Nume și adresă vânzător / Název a adresa prodejece / Nama dan alamat peruncit / Nama Toko Penjual dan alamat / Tên và địa chỉ cửa hàng bán/ Saticı firmanın adı ve adresi / Название и адрес прџдавца / Назва i adresa прџдавця / Търговски пбект / Назив и адреса на прџдавницата / Сатушының аты және мекен-жайы / Επωρυμία και διεύθυνση καηαζηήματος / Վեճմանքի անվանումը և հասցեն / ชื่อและที่อยู่ของห้าง/ร้านที่ซื้อ / 零售商店的店名和地址/販売店の名前、住所/소매점 이름과 주소 / نام و آدرس خرده فروش / اسم وعنوان بائع التجزئة

Distributor stamp Cachet distributeur / Sello del distribuidor / Carimbo do revendedor / Timbro del negozio / Händlerstempel / Stempel van de retailer / Forhandler stempel / Återförsäljarens stämpel / Forhandler stempel / Jälleenmyyjän leima / pieczęć sprzedawcy / Ştampila vânzătorului / Antspaudas / Tempel / Žig trgovine / Eladó neve, címe/ Razítko predajcu / Zīmogs / Pečat maloprodaje/ Pečat prodavca / Pečat prodajnog mjesta / Ştampila vânzătorului/ Razítko prodejece/ Cap peruncit / Cap dari Toko Penjual / Cửa hàng bán đồng dấu/ Saticı Firmanın Kaşesi / Печать прџдавца / Печатка прџдавця / Печат на търговския пбект / Печат на прџдавницата / Сатушының мөрі / Σηραγίδα καηαζηήματος / Վեճմանքի Լիճիք / ตราประทับของห้าง/ร้านที่ซื้อ / 零售商的盖印 / 販売店印 / 소매점 직인 / فروش مهر خرده / ختم بائع التجزئة

Moulinex®
m4000