



MARQUE: MOULINEX

REFERENCE: AM338070

CODIC: 4251059



NOTICE



compact pro

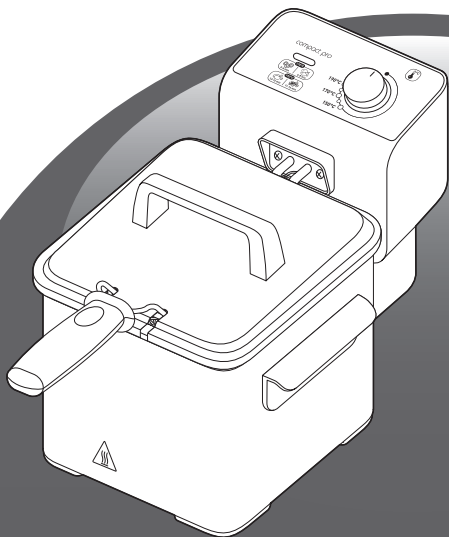

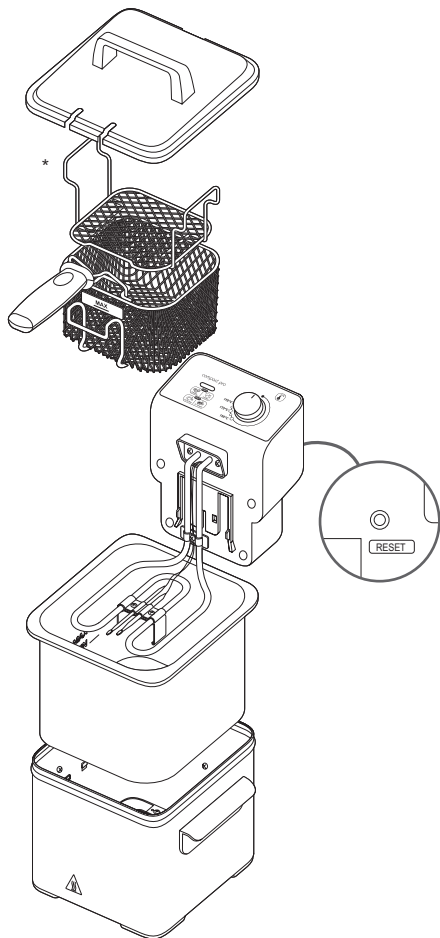

* Selon modèle/ Afhankelijk van de model/ Je nach Modell/ Depending on model/ Secondo il modello/ Según modelo/ Consoante o modelo/ Ανάλογα με το μοντέλο/ Modele göre/ Afhängigt af modellen/ Beroende på modell/ Avhengig av modell/ Mallista riippuen/ Ovisno o modelu/ U zavisnosti od modela/ Odvisno od modela/ Zależnie od modelu/ Podle typu/ Podla typu/ Bizonyos típusoknál/ В зависимости от модели/ У зависимости од модели/ În funcție de model/ Vastavalt mudelitele/ Atbilstoši paraugiem/ Pagal modeliūs/ بحسب الموديل/ 根据型号

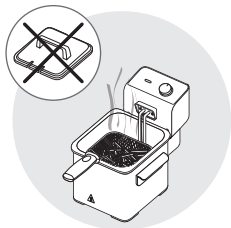
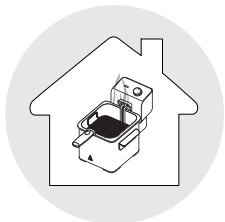
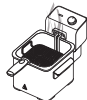

2

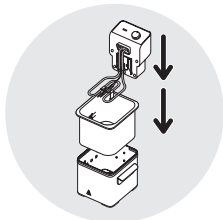
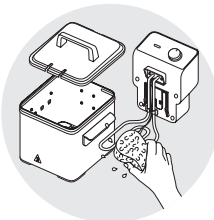
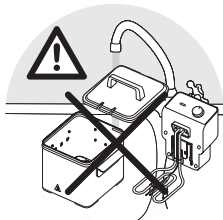
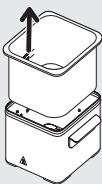
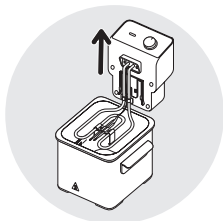
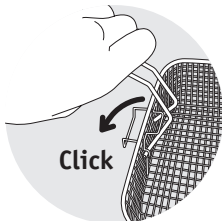
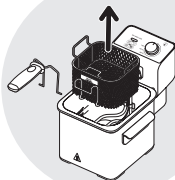
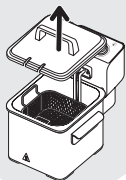

4

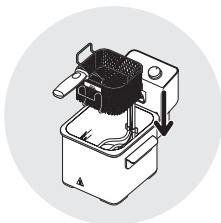
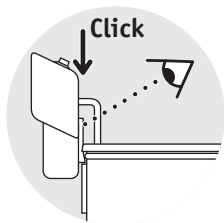

3



Min 1,85L
Max 2,2L

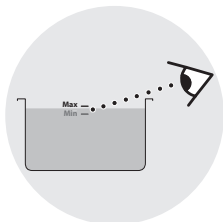
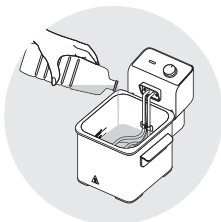



Max 600g

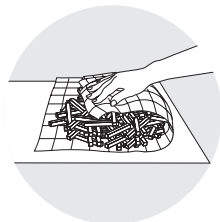



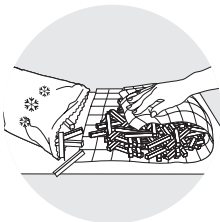

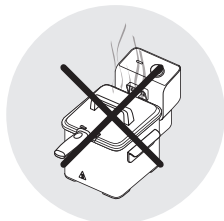
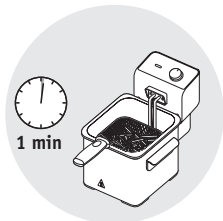
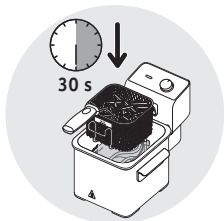
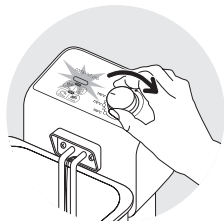
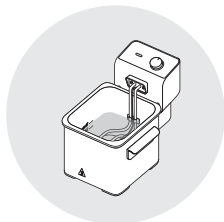
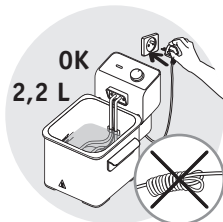
Max 500g







	Nb			
		600g	180°C	14 min
	18	-	190°C	3-4 min
 *	8	-	170°C	15 min
***	Nb			
		500g	190°C	9 min
	-	600g	190°C	5 min
	-	200g	160°C	5 min

*

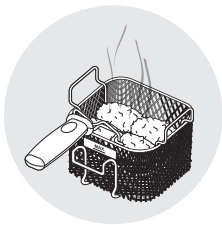
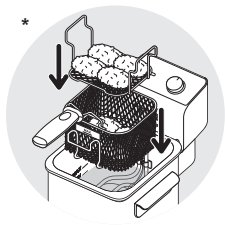



7

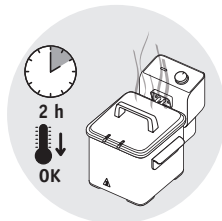
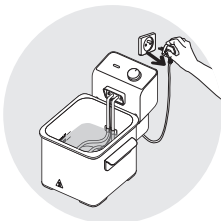
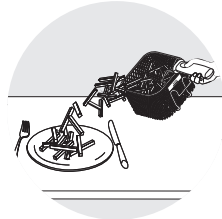
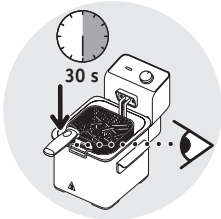
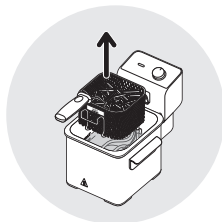
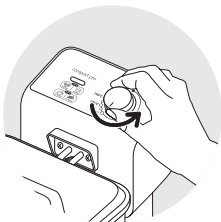

9

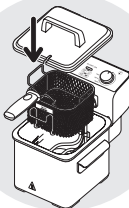
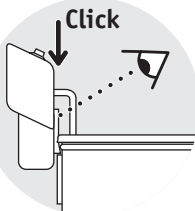
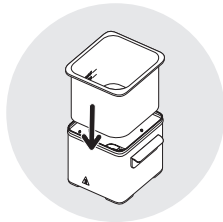
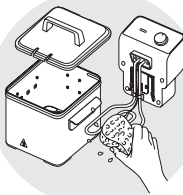
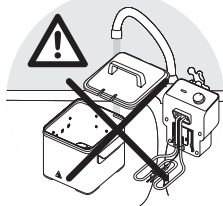
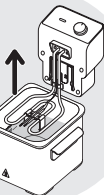
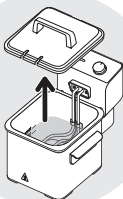

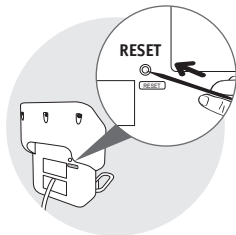
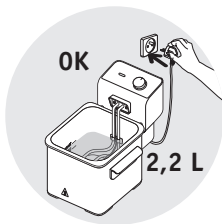
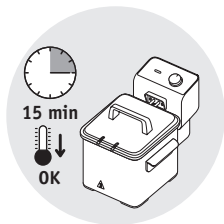
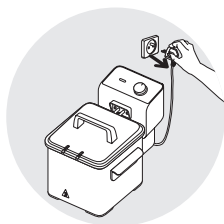
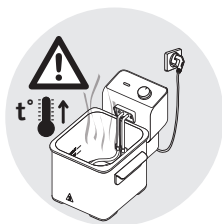
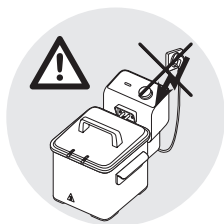
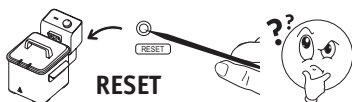

10

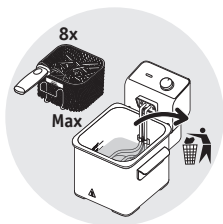





11







12

GUARANTEE COUNTRY LIST

			
ARGENTINA	0800-122-2732	2 años 2 years	GRUPE SEB ARGENTINA S.A. Billinghurst 1833 3° C1425DTK Capital Federal Buenos Aires
ՀԱՅԱՍՏԱՆ ARMENIA	010 55-76-07	2 տարի 2 years	ՓԲԸ <<ԳՐՈՒՊԱ ՄԵԲ>> 125171, ՄՈՍԿՎԱ, ԼԵՆԻՆԳՐԱԴՑԱՆ ԽՃՈՒՂԻ, 16A, ՇԻՆ.3
AUSTRALIA	1300307824	1 year	GRUPE SEB AUSTRALIA PO Box 7535, Silverwater NSW 2128
ÖSTERREICH AUSTRIA	01 890 3476	2 Jahre 2 years	SEB ÖSTERREICH GmbH Campus 21 - Businesspark Wien Süd, Liebermannstr. A02 702 2345 Brunn am Gebirge
البحرين BAHRAIN	17716666	1 year	www.tefal-me.com
БЕЛАРУСЬ BELARUS	017 2239290	2 года 2 years	ЗАО «Группа СЕБ-Восток», 125171, Москва, Ленинградское шоссе, д. 16А, стр. 3
BELGIQUE BELGIE BELGIUM	070 23 31 59	2 ans 2 jaar 2 years	GRUPE SEB BELGIUM SA NV 25 avenue de l'Espérance - ZI 6220 Fleurus
BOSNA I HERCEGOVINA	Info-linija za potrošače 033 551 220	2 godine 2 years	SEB Developpement Predstavništvo u BiH Vrazova 8/II 71000 Sarajevo
BRASIL BRAZIL	11 2915-4400	1 ano 1 year	SEB COMERCIAL DE PRODUTOS DOMÉSTICOS LTDA Rua Venâncio Aires, 433, Pompéia, São Paulo/SP
БЪЛГАРИЯ BULGARIA	0700 10 330	2 години 2 years	ГРУП СЕБ БЪЛГАРИЯ ЕООД бул. България 81 В, ет. 5 1404 София
CANADA	1-800-418-3325	1 an 1 year	GRUPE SEB CANADA 345 Passmore Avenue Toronto, ON M1V 3N8
CHILE	12300 209207	2 años 2 years	GRUPE SEB CHILE Comercial Ltda Av. Providencia, 2331, piso 5, oficina 501 Santiago
COLOMBIA	018000520022	2 años 2 years	GRUPE SEB COLOMBIA Apartado Aereo 172, Kilometro 1 Via Zipaquira Cajica Cundinamarca
HRVATSKA CROATIA	01 30 15 294	2 godine 2 years	SEB mku & p d.o.o. Vodnjanska 26, 10000 Zagreb
ČESKÁ REPUBLIKA CZECH REPUBLIC	731 010 111	2 roky 2 years	Groupe SEB ČR s.r.o. Futurama Business Park (budova A) Sokolovská 651/136a 186 00 Praha 8
DANMARK DENMARK	44 663 155	2 år 2 years	GRUPE SEB NORDIC AS Tempovej 27 2750 Ballerup
مصر EGYPT	16622	سنة واحدة 1year	جروب سب ایجیبت القاهرة: ١٢١ شارع الحجاز، مصر الجديدة الإسكندرية: طريق أم مايو، سموحة

			
EESTI ESTONIA	668 1286	2 aastat 2 years	GRUPE SEB POLSKA Sp. z o.o. ul. Bukowińska 22b 02-703 Warszawa
SUOMI FINLAND	09 622 94 20	2 Vuotta 2 years	Groupe SEB Finland Kutojantie 7 02630 Espoo
France Continentale + Guadeloupe, Martinique, Réunion, Saint-Martin	09 74 50 47 74	1 an 1 year	GRUPE SEB France Service Consommateur Tefal 112 Ch. Moulin Carron, TSA 92002 69134 ECULLY Cedex
DEUTSCHLAND GERMANY	0212 387 400	2 Jahre 2 years	GRUPE SEB DEUTSCHLAND GmbH / KRUPS GmbH Theodor-Stern-Kai 1 60486 Frankfurt am Main
ELLADA GREECE	2106371251	2 χρόνια 2 years	SEB GROUPE ΕΛΛΑΔΟΣ Α.Ε. Οδός Καβαλιεράτου 7 Τ.Κ. 145 64 Κ. Κηφισιά
香港 HONG KONG	8130 8998	1 year	SEB ASIA Ltd. Room 903, 9/F, South Block, Skyway House 3 Sham Mong Road, Tai Kok Tsui, Kowloon Hong-Kong
MAGYARORSZÁG HUNGARY	06 1 801 8434	2 év 2 years	GRUPE SEB CENTRAL-EUROPE Kft. Táviró köz 4 2040 Budaörs
INDONESIA	+62 21 5793 7007	1 year	GRUPE SEB INDONESIA (Representative office) Sudirman Plaza, Plaza Marein 8th Floor JL Jendral Sudirman Kav 76-78, Jakarta 12910, Indonesia
ITALIA ITALY	1 99 207 354	2 anni 2 years	GRUPE SEB ITALIA S.p.A. Via Montefeltro, 4 20156 Milano
日本 JAPAN	0570-077772	1 year	株式会社グループセブジャパン 〒144-0042 東京都大田区羽田旭町11-1 羽田クロノゲート事務棟5F
الاردن JORDAN	5665505	1 year	www.tefal-me.com
ҚАЗАҚСТАН KAZAKHSTAN	727 378 39 39	2 жыл 2 years	ЖАҚ «Группа СЕБ- Восток» 125171, Мәскеу, Ленинградское шоссеі, 16А, 3 үйі
한국어 KOREA	1588-1588	1 year	(유)그림 세브 코리아 서울시 종로구 청계천로 35 관정빌딩 2층 110- 790
الكويت KUWAIT	24831000	1 year	www.tefal-me.com
LATVIJA LATVIA	6 616 3403	2 gadi 2 years	GRUPE SEB POLSKA Sp. z o.o. ul. Bukowińska 22b, 02-703 Warszawa
لبنان LEBANON	4414727	1 year	www.tefal-me.com
LIETUVA LITHUANIA	5 214 0057	2 metai 2 years	GRUPE SEB POLSKA Sp. z o.o. ul. Bukowińska 22b, 02-703 Warszawa
LUXEMBOURG	0032 70 23 31 59	2 ans 2 years	GRUPE SEB BELGIUM SA NV 25 avenue de l'Espérance - ZI 6220 Fleurus

			
МАКЕДОНИЈА MACEDONIA	(02) 20 50 319	2 години 2 years	Grupe SEB Bulgaria EOOD Office 1, floor 1, 52G Borovo St., 1680 Sofia - Bulgaria ГРУП СЕБ БЪЛГАРИЈА ДООЕЛ Ул. Борово 52 Г, сп. 1, офис 1, 1680 София, България
MALAYSIA	603 7802 3000	1 year	GRUPE SEB MALAYSIA SDN. BHD Unit No. 402-403, Level 4, Uptown 2, No. 2, Jalan SS21/37, Damansara Uptown, 47400, Petaling Jaya, Selangor D.E Malaysia
MEXICO	(01800) 112 8325	1 año 1 year	Grupe.S.E.B. México, S.A. DE C.V. Goldsmith 38 Desp. 401, Col. Polanco Delegación Miguel Hidalgo 11 560 México D.F.
MOLDOVA	22 929249	2 роки 2 years	ТОВ «Груп СЕБ Україна» 02121, Харківське шосе, 201-203, 3 поверх, Київ, Україна
NEDERLAND The Netherlands	0318 58 24 24	2 jaar 2 years	GRUPE SEB NEDERLAND B.V. De Schutterij 27 3905 PK Veenendaal
NEW ZEALAND	0800 700 711	1 year	GRUPE SEB NEW ZEALAND PO Box 17 – 298, Greenlane, 1546 Auckland New Zealand
NORGE NORWAY	815 09 567	2 år 2 years	GRUPE SEB NORDIC AS Tempovej 27 2750 Ballerup
عمان سلطنة OMAN	24703471	1 year	www.tefal-me.com
POLSKA POLAND	801 300 420 koszt jak za połączenie lokalne	2 lata 2 years	GRUPE SEB POLSKA Sp. z o.o. ul. Bukowińska 22b 02-703 Warszawa
PORTUGAL	808 284 735	2 anos 2 years	GRUPE SEB IBÉRICA SA Urb. da Matinha Rua Projectada à Rua 3 Bloco1 - 3° B/D 1950 - 327 Lisboa
قطر QATAR	44485555	1 year	www.tefal-me.com
REPUBLIC OF IRELAND	01 677 4003	1 year	GRUPE SEB IRELAND Unit B3 Aerodrome Business Park, College Road, Rathcoole, Co. Dublin
ROMANIA	0 21 316 87 84	2 ani 2 years	GRUPE SEB ROMÂNIA Str. Daniel Constantin nr. 8 010632 București
РОССИЯ RUSSIA	495 213 32 30	2 года 2 years	ЗАО «Группа СЕБ-Восток», 125171, Москва, Ленинградское шоссе, д. 16А, стр. 3
المملكة العربية السعودية SAUDI ARABIA	920023701	1 year	www.tefal-me.com
SRBIJA SERBIA	060 0 732 000	2 godine 2 years	SEB Developpement Đorđa Stanojevića 11b 11070 Novi Beograd

			
SINGAPORE	6550 8900	1 year	GRUPE SEB SINGAPORE Pty Ltd. 59 Jalan Pemimpin, #04-01/02 L&Y Building Singapore 577218
SLOVENSKO SLOVAKIA	232 199 930	2 roky 2 years	GRUPE SEB Slovensko, spol. s r.o. Cesta na Senec 2/A 821 04 Bratislava
SLOVENIJA SLOVENIA	02 234 94 90	2 leti 2 years	SEB d.o.o. Gregorčičeva ulica 6 2000 MARIBOR
SOUTH AFRICA	0100202222	1 year	GS South Africa Building 17, PO BOX 107 The Woodlands Office Park, 20 Woodlands Drive, Woodmead 2080
ESPAÑA SPAIN	902 31 24 00	2 años 2 years	GRUPE SEB IBÉRICA S.A. C/ Almogàvers, 119-123, Complejo Ecourban 08018 Barcelona
SVERIGE SWEDEN	08 594 213 30	2 år 2 years	TEFAL SVERIGE SUBSIDIARY OF GRUPE SEB NORDIC Truckvägen 14 A, 194 52 Upplands Väsby
SUISSE SCHWEIZ SWITZERLAND	044 837 18 40	2 ans 2 Jahre 2 years	GRUPE SEB SCHWEIZ GmbH Thurgauerstrasse 105 8152 Glattbrugg
ประเทศไทย THAILAND	02 769 7477	2 years	GRUPE SEB THAILAND 2034/66 Italthai Tower, 14th Floor, n° 14-02, New Phetchburi Road, Bangkapi, Huaykwang, Bangkok, 10320
TÜRKIYE TURKEY	444 40 50	2 YIL 2 years	GRUPE SEB ISTANBUL AS Dereboyu Cd. Bilim Sk. Sun Plaza No:5 K:2 Maslak/IST
المملكة العربية الإمارات UAE	8002272	1 year	www.tefal-me.com
Україна UKRAINE	044 300 13 04	2 роки 2 years	ТОВ «Груп СЕБ Україна» 02121, Харківське шосе, 201-203, 3 поверх, Київ, Україна
UNITED KINGDOM	0345 602 1454	1 year	GRUPE SEB UK LTD Riverside House, Riverside Walk Windsor, Berkshire, SL4 1NA
U.S.A.	800-395-8325	1 year	GRUPE SEB USA 2121 Eden Road Millville, NJ 08332
VENEZUELA	0800-7268724	2 años 2 years	GRUPE SEB VENEZUELA Av Eugenio Mendoza, Centro Letonia, Torre ING Bank, Piso 15, Ofc 155 Urb. La Castellana, Caracas

25/03/2015

INTERNATIONAL GUARANTEE

Date of purchase: / Date d'achat / Fecha de compra / Data da compra / Data d'acquisto / Kaufdatum / Aankoopdatum / Kobsdato / Inköpsdatum / Kjøpsdato / Ostopäivä / Data zakupu / Data vânzării / [sigijimo data/ Ostukuupäev / Datum nakupa / Sorozatszám / Dátum nákupu / Pirkuma datums / Datum Kupovine / Datum kupnje / Data cumpărării / Datum nákupu / Tarikh pembelian / Tanggal pembelian / Ngily maa háng / Satm alma tarihi / Дата продажи / Дата на закупуване / Датум на купување / Сатылган мерзімі / Ημερομηνία αγοράς / Ύψιστης ημερ / 購買日期 / 購入日 / 구입일자 / تاريخ الشراء / تاريخ خري / بتاريخ الشراء /

Product reference: / Référence du produit / Referencia del producto / Nome do produto / Tipo de prodotto / Tynnummer des Gerätes / Artikelnummer van het apparaat / Referencenummer / Produktreferens / Artikelnummer / Tuotenumero / referencia produktu / Model / Gaminio numeris / Toote viitenumber / Тип аппарата / Vásárlás kelte / Тип výrobku / Produkta atsauces numurs / Model proizvoda / Oznaka proizvoda / Cod produs / Produk rujukan / Referensi produk / Mã sản phẩm / Ürün kodu / Модель / Модель / Модел на уред / Модели / Кодовός προϊόντος / Униқ / Ύψιστης ημερ / 產品模型 / 製品番号 / 제품명 / مرجع المنتج الكامل / مرجع المنتج الكامل /

Retailer name & address: / Nom et adresse du vendeur / Nombre y dirección del minorista / Nome e endereço do revendedor / Nome e indirizzo del negozio / Name und Anschrift des Händlers / Naam en adres van de dealer / Forhandler navn & adresse / Återförsäljarens namn och adress / Forhandler navn og adresse / Jälleenmyyjän nimi ja osoite / nazwa i adres sprzedawcy / Numele și adresa vânzătorului / Parđuotuvės pavadinimas ir adresas / Mütiija kauplus ja address / Naziv in naslov trgovine / Tipusszám / Názov a adresa predajcu / Veikala nosaukums un adrese / Naziv i adresa malprodaje / Naziv i adresa prodavca / Naziv i adresa prodajnog mjesta / Nume și adresă vânzător / Název a adresa prodeje / Nama dan alamat perancis / Nama Toko Penjual dan alamat / Tên và địa chỉ cửa hàng bán/ Sateci firmann adı ve adresi / Название и адрес продавца / Назва i adresa prodavca / Търговски обект / Назва и адреса на продавницата / Сатушынын аты және мекен-жайы / Εμπορική και διεθρονη κατοστηματος / Ύψιστης ημερ / 零售商的店名和地址 / 販売店名、住所 / 소매점 이름과 주소 / نام درس خرد فروش / اسم باع التجرة و عنوانه / نام باع التجرة و عنوانه /

Distributor stamp / Cachet distributeur / Sello del distribuidor / Carimbo do revendedor / Timbro del negozio / Händlerstempel / Stempel van de dealer / Forhandler stempel / Återförsäljarens stämpel / Forhandler stempel / Jälleenmyyjän leima / pieczęć sprzedawcy / Ștampila vânzătorului / Antspaudas / Tempel / Žig trgovine / Eladó neve, címe/ Razitko predajcu / Zmogs / Pečat malprodaje/ Pečat prodavca / Pečat prodajnog mjesta / Ștampila vânzătorului/ Razitko prodeje/ Cap rençit / Cap dari Toko Penjual / Cửa hàng bán đồng dấu/ Sateci Firmann Kaşesi / Печать продавца / Печат на търговския обект / Печат на продавницата / Сатушынын мөрі / Σφραγίδα κατοστηματος / Ύψιστης ημερ / 零售商的蓋印 / 販売店印 / 販売店印 / 소매점 직인 / مهر خرد فرو / نام باع التجرة /

NC00134921