

# MOULINEX

## FRITEUSE

### AF2031

## MANUEL D'UTILISATION



Besoin d'aide ? Rendez-vous sur <https://sav.darty.com>

uno

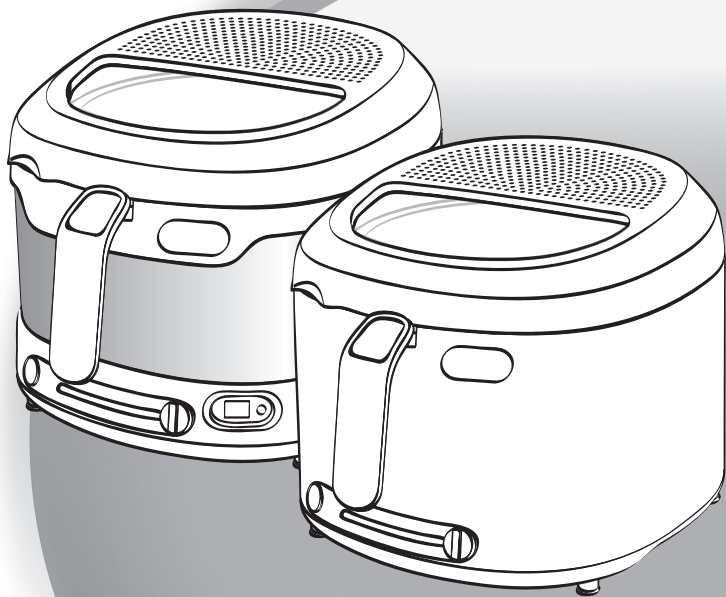

[www.groupeseb.com](http://www.groupeseb.com)

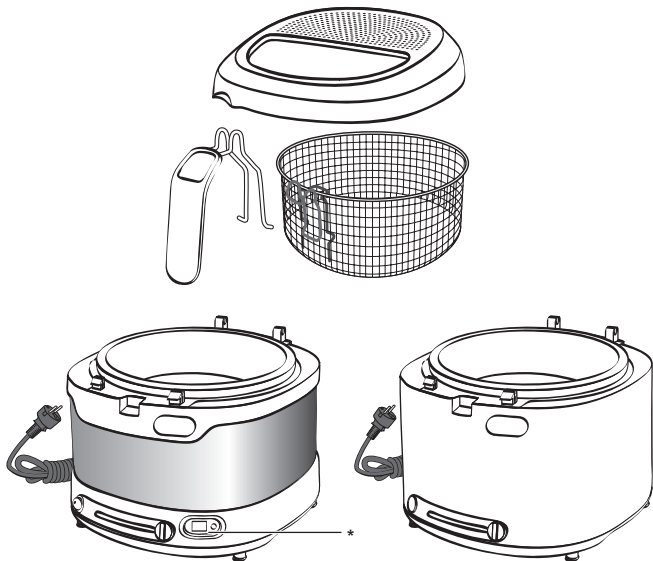

\*selon modèle • depending on model • je nach Modell • a seconda del modello • según modelo • consoante os modelos • Ανάλογα με το μοντέλο • В зависимости от модели • Залежно від моделі • zależnie od modelu • az egyes modellek szerint • podle modelů • podľa modelov • В зависимости от модели • În funcție de model • modellere göre • Зависо од модела • zavisno od modela • Ólede na model • بحسب الموديل • بر حسب مدل • afhængig af modellen • beroende på modell • avhengig av modell • mallista riippuen • залежно від моделі • үлгіге байланысты • vastavalt mudelitele • atkarībā no modeļa • pagal modelius • zależnie od modelu • у зависимости од модела • glede na model • zavisno od modela • в зависимости от модела • în funcție de model • 視乎型號而定 • 모델에 따라 다름 • แดกต่างกันไปเนโมเดลซุ่น • bergantung pada model

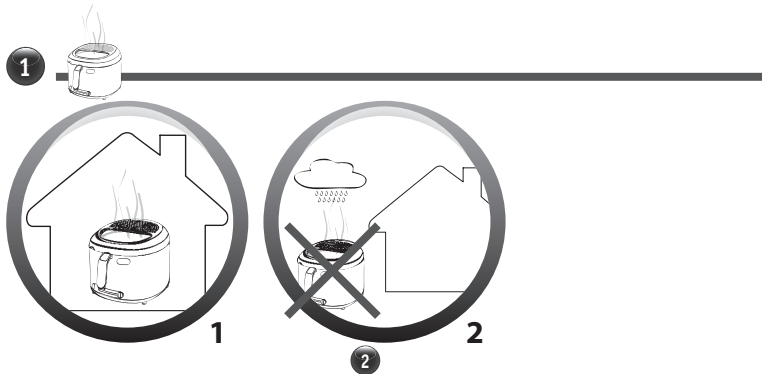

2

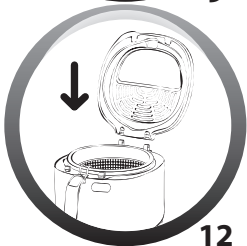
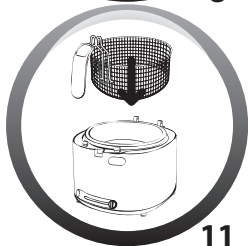
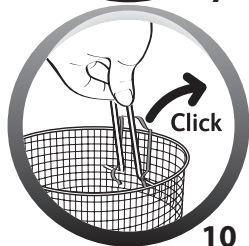
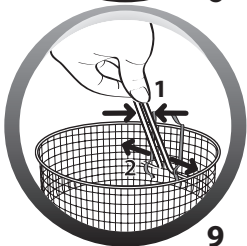
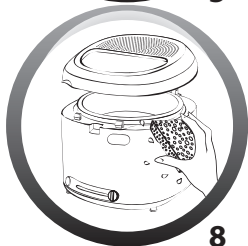
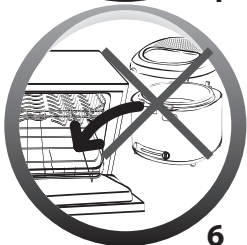
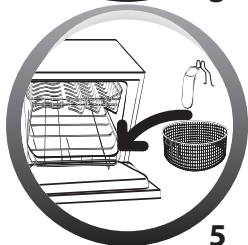
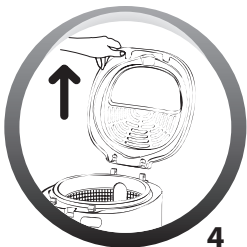

3



MIN 1,6 L  
MAX 1,8 L

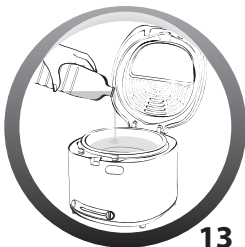

13

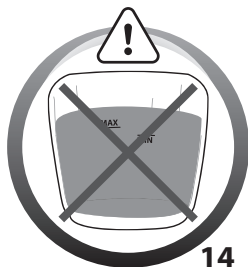

14



15



16



17



18

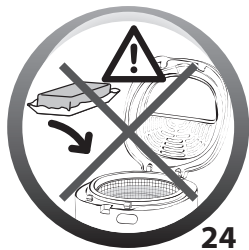
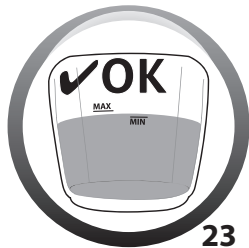
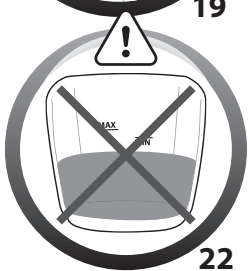
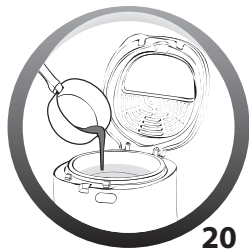
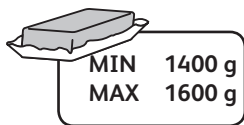



MAX 800 g



500 g



27

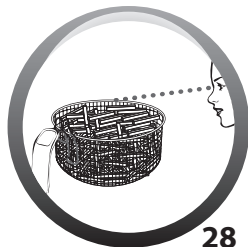

28



29



MAX 750 g



380 g

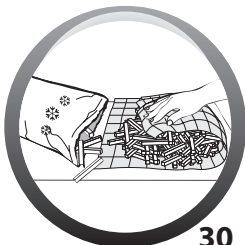

30

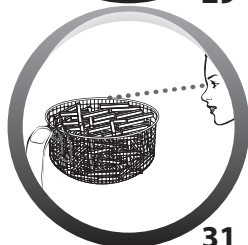

31



32



33



34

5



0 L

35

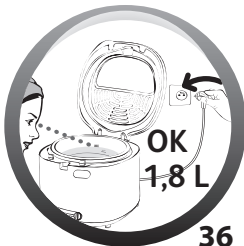

OK  
1,8 L

36

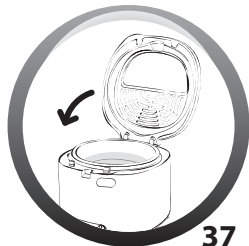

37

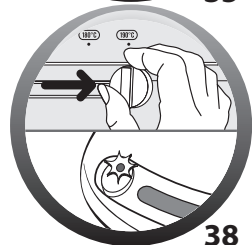

38

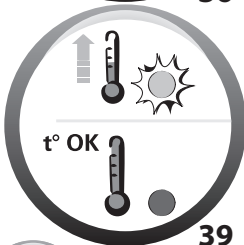

t° OK

39

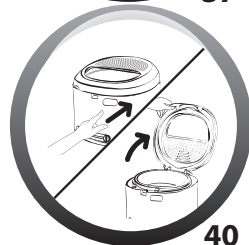

40

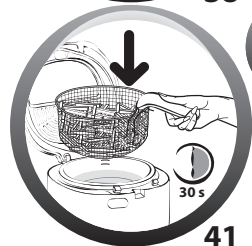

41

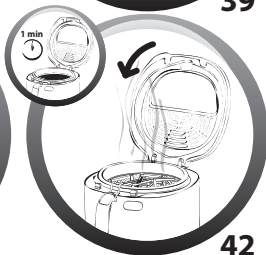

42

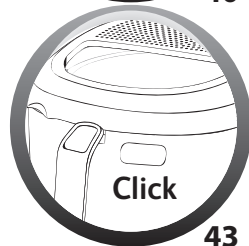

43

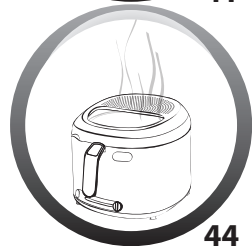

44



45

7





46



47

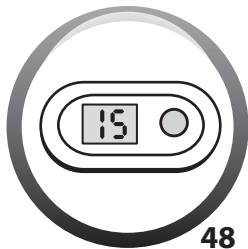

48

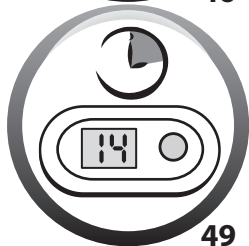

49

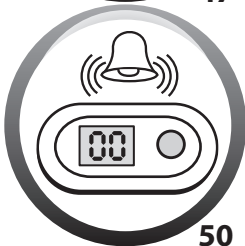



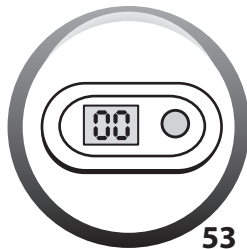
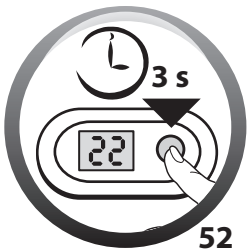
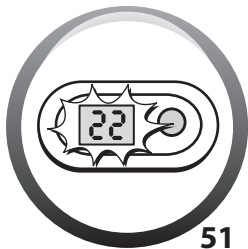

























50



\*selon modèle • depending on model • je nach Modell • a seconda del modello • según modelo • consoante os modelos • Ανάλογα με το μοντέλο • В зависимости от модели • Залежно від моделі • zależnie od modelu • az egyes modellek szerint • podle modelů • podľa modelov • В зависимости от модели • În funcție de model • modellere göre • Зависно од модела • zavisno od modela • Ólede na model • بحسب الموديل • بر حسب مدل • afhængig af modellen • beroende på modell • avhengig av modell • mallista riippuen • залежно від моделі • үлгіге байланысты • vastavalt mudelitele • atkarībā no modeļa • pagal modelių • zależnie od modelu • у зависимости од модела • glede na model • zavisno od modela • в зависимости от модела • în funcție de model • 視乎型號而定 • 모델에 따라 다름 • แดกต่างกันไปโมเดลละ • bergantung pada model



	Nb		 °C	
		800 g	1) 160°C	7-8 min
			2) 190°C	5-6 min
		800 g	190°C	11-14 min
		500 g	190°C	9-11 min
		3-4	180°C	15-20 min
		2	160°C	6-8 min
		8	150°C	6-8 min
		10-12	180°C	6-7 min
		500 g	180°C	4-5 min
		4	170°C	7-8 min
	Nb		 °C	
		750 g	190°C	12-14 min
		380 g	190°C	6-7 min
		3-4	190°C	18-20 min
		2	190°C	6-8 min
		22 g	190°C	4-5 min
		1 Kg	190°C	8-9 min
		5	190°C	4-5 min

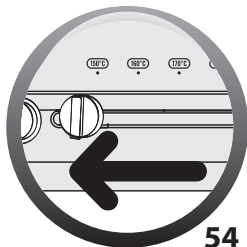

54



55



56

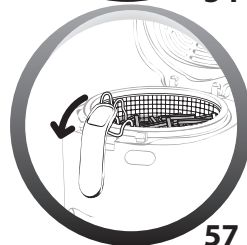

57

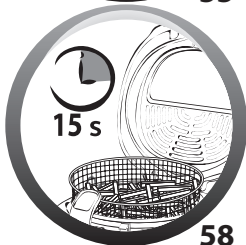

58



59

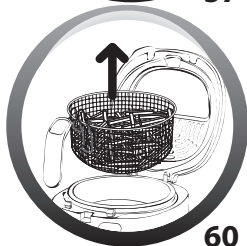

60

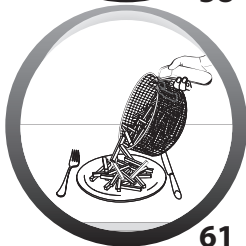

61

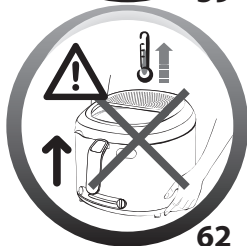

62

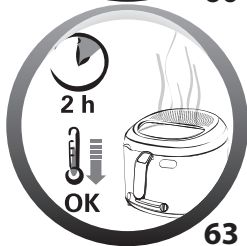

63

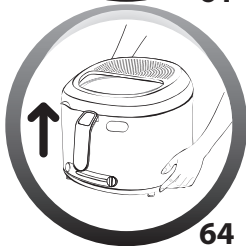

64



65



66

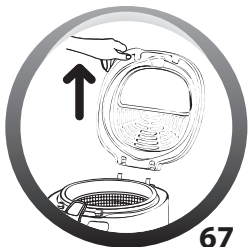

67

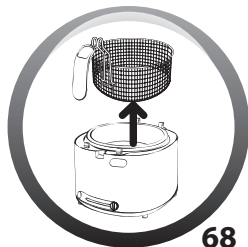

68

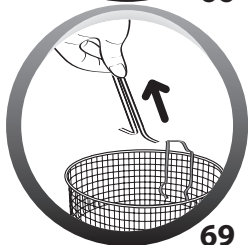

69

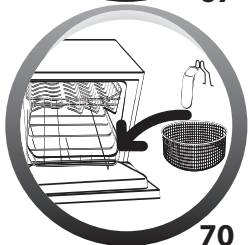

70

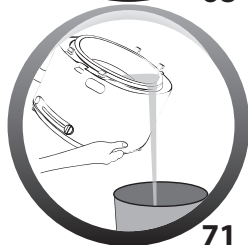

71

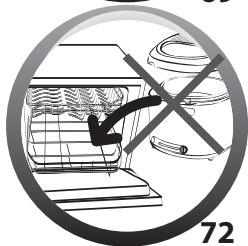

72

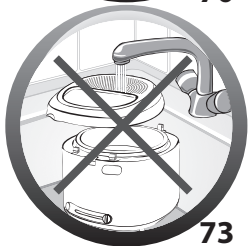

73

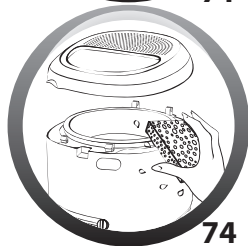

74

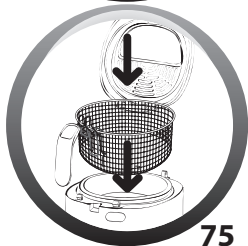

75

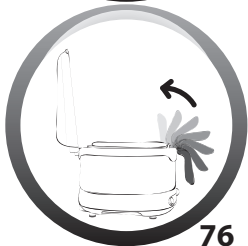

76

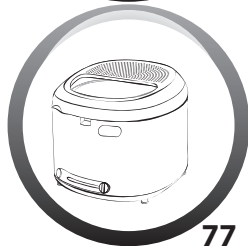

77

11

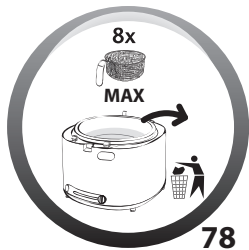

78



79

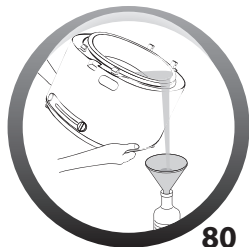

80



81

12



82

13







Ref. NC00152228

**[www.groupeseb.com](http://www.groupeseb.com)**